



排水

特長

1. 外側線(白線)が明確に引けます。
2. 側溝天端勾配を6%からレベルに摺り付けた製品もあり転倒・衝撃を解消します。
3. 表面模様のノスキッド仕上げにより、スリップ事故を軽減します。
4. 側溝両端部を一体構造とし、製品長を2500mmとしました。
5. 側壁部が垂直なため、十分な転圧が可能です。
6. 側溝本体が防音ゴム付きのため、騒音を防止します。

ノスキッド仕上げ(ノンスリップ対応)

- スリップ事故を軽減
- 雨天時の車輛反射光を低減
- 表面の雨水をすばやく排水



縦断用

縦断用標準型

断面図

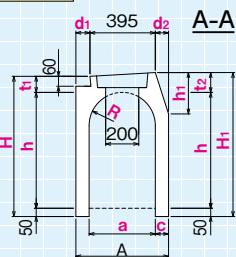

側面図

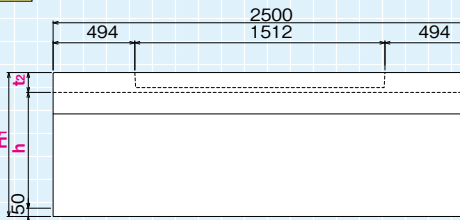

断面図

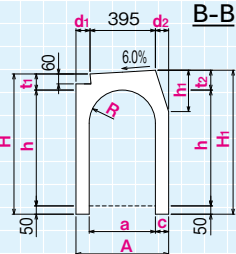

平面図

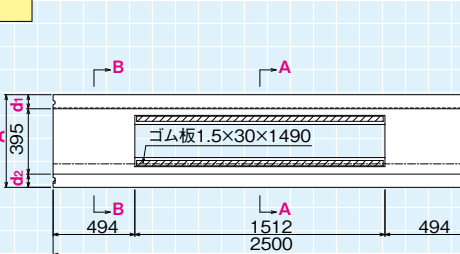

縦断用摺り付けタイプ

断面図

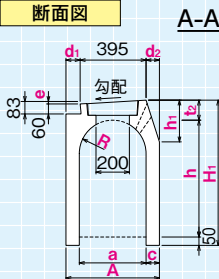

側面図

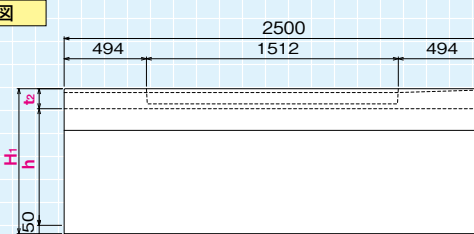

6%~0%、6%~2%、2%~0%
摺り付けタイプ

- 左右摺り付け用もあります。

断面図

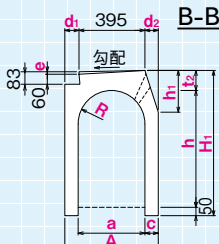

平面図

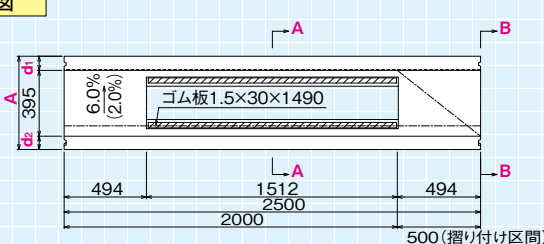

勾配	e (mm)
6% ~ 0%	23
6% ~ 2%	15
2% ~ 0%	8

YCL側溝 可変型(T-25)縦断用・横断用

●寸法表 (単位: mm)													●基礎数量表 (10m当り)						
呼び名 (a × h)	H	H ₁	A	t ₁	t ₂	d ₁	d ₂	c	h ₁	R	参考質量 (kg)	呼び名 (a × h)	A	b ₁	b ₂	基礎材 (m ²)	基礎コンクリート (m ³)		
300x	300	432	455	450	82	105	35	20	75	100	150	490	300x	450	50	100	5.50	0.275	
	400	532	555									580							
	500	632	655									670							
	600	732	755	450	82	105	35	20	75	100	150	760		700	450	50	100	5.50	0.275
	700	832	855									850							
	800	932	955									940							
	900	1032	1055	450	82	105	35	20	75	100	150	1030		1000	450	50	100	5.50	0.275
	1000	1132	1155									1120							
	1100	1232	1255									1210							
	1200	1332	1355	560	97	120	85	80	80	250	200	1300		400x	560	70	100	6.60	0.462
400	547	570	690																
500	647	670	780																
600	747	770	880																
700	847	870	980																
800	947	970	1070																
900	1047	1070	1170																
1000	1147	1170	1260																
1100	1247	1270	1360																
1200	1347	1370	1460																
1300	1447	1470	690	127	150	200	95	95	350	250	1560	500x	690	90	100	7.90	0.711		
500	677	700									1040								
600	777	800									1150								
700	877	900									1260								
800	977	1000									1380								
900	1077	1100									1490								
1000	1177	1200									1610								
1100	1277	1300									1720								
1200	1377	1400									1830								
1300	1477	1500									1950								
1400	1577	1600	2060																
1500	1677	1700	2180	800	142	165	275	130	100	400	300	1320	600x	800	120	150	9.00	1.080	
600	792	815	1440																
700	892	915	1560																
800	992	1015	1680																
900	1092	1115	1800																
1000	1192	1215	1920																
1100	1292	1315	2040																
1200	1392	1415	2160																
1300	1492	1515	2280																
1400	1592	1615	2400																
1500	1692	1715	2520																
1600	1792	1815										1320	600x	800	120	150	9.00	1.080	
600	792	815	1440																
700	892	915	1560																
800	992	1015	1680																
900	1092	1115	1800																
1000	1192	1215	1920																
1100	1292	1315	2040																
1200	1392	1415	2160																
1300	1492	1515	2280																
1400	1592	1615	2400																
1500	1692	1715	2520																
1600	1792	1815										1320	600x	800	120	150	9.00	1.080	
600	792	815	1440																
700	892	915	1560																
800	992	1015	1680																
900	1092	1115	1800																
1000	1192	1215	1920																
1100	1292	1315	2040																
1200	1392	1415	2160																
1300	1492	1515	2280																
1400	1592	1615	2400																
1500	1692	1715	2520																
1600	1792	1815										1320	600x	800	120	150	9.00	1.080	
600	792	815	1440																
700	892	915	1560																
800	992	1015	1680																
900	1092	1115	1800																
1000	1192	1215	1920																
1100	1292	1315	2040																
1200	1392	1415	2160																
1300	1492	1515	2280																
1400	1592	1615	2400																
1500	1692	1715	2520																
1600	1792	1815										1320	600x	800	120	150	9.00	1.080	
600	792	815	1440																
700	892	915	1560																
800	992	1015	1680																
900	1092	1115	1800																
1000	1192	1215	1920																
1100	1292	1315	2040																
1200	1392	1415	2160																
1300	1492	1515	2280																
1400	1592	1615	2400																
1500	1692	1715	2520																
1600	1792	1815										1320	600x	800	120	150	9.00	1.080	
600	792	815	1440																
700	892	915	1560																
800	992	1015	1680																
900	1092	1115	1800																
1000	1192	1215	1920																
1100	1292	1315	2040																
1200	1392	1415	2160																
1300	1492	1515	2280																
1400	1592	1615	2400																
1500	1692	1715	2520																
1600	1792	1815										1320	600x	800	120	150	9.00	1.080	
600	792	815	1440																
700	892	915	1560																
800	992	1015	1680																
900	1092	1115	1800																
1000	1192	1215	1920																
1100	1292	1315	2040																
1200	1392	1415	2160																
1300	1492	1515	2280																
1400	1592	1615	2400																
1500	1692	1715	2520																
1600	1792	1815										1320	600x	800	120	150	9.00	1.080	
600	792	815	1440																
700	892	915	1560																
800	992	1015	1680																
900	1092	1115	1800																
1000	1192	1215	1920																
1100	1292	1315	2040																
1200	1392	1415	2160																
1300	1492	1515	2280																
1400	1592	1615	2400																
1500	1692	1715	2520																
1600	1792	1815										1320	600x	800	120	150	9.00	1.080	
600	792	815	1440																
700	892	915	1560																
800	992	1015	1680																
900	1092	1115	1800																
1000	1192	1215	1920																
1100	1292	1315	2040																
1200	1392	1415	2160																
1300	1492	1515	2280																
1400	1592	1615	2400																
1500	1692	1715	2520																
1600	1792	1815										1320	600x	800	120	150	9.00	1.080	
600	792	815	1440																
700	892	915	1560																
800	992	1015	1680																
900	1092	1115	1800																
1000	1192	1215	1920																
1100	1292	1315	2040																
1200	1392	1415	2160																
1300	1492	1515	2280																
1400	1592	1615	2400																
1500	1692	1715	2520																
1600	1792	1815										1320	600x	800	120	150	9.00	1.080	
600	792	815	1440																
700	892	915	1560																
800	992	1015	1680																
900	1092	1115	1800																
1000	1192	1215	1920																
1100	1292	1315	2040																
1200	1392	1415	2160																
1300	1492	1515	2280																
1400	1592	1615	2400																
1500	1692	1715	2520																
1600	1792	1815										1320	600x	800	120	150	9.00	1.080	
600	792	815	1440																
700	892	915	1560																
800	992	1015	1680																
900	1092	1115	1800																
1000	1192	1215	1920																
1100	1292	1315	2040																
1200	1392	1415	2160																
1300	1492	1515	2280																
1400	1592	1615	2400																
1500	1692	1715	2520																
1600	1792	1815										1320	600x	800	120	150	9.00	1.080	
600	792	815	1440																
700	892	915	1560																
800	992	1015	1680																
900	1092	1115	1800																
1000	1192	1215	1920																
1100	1292	1315	2040																
1200	1392	1415	2160																
1300	1492	1515	2280																
1400	1592	1615	2400																
1500	1692	1715	2520																
1600	1792	1815										1320	600x	800	120	150	9.00	1.080	
600	792	815	1440																
700	892	915	1560																
800	992	1015	1680																
900	1092	1115	1800																
1000	1192	1215	1920																
1100	1292	1315	2040																
1200	1392	1415	2160																
1300	1492	1515	2280																
1400	1592	1615	2400																
1500	1692	1715	2520																
1600	1792	1815										1320	600x	800	120	150	9.00	1.080	
600	792	815	1440																
700	892	915	1560																
800	992	1015	1680																
900	1092	1115	1800																
1000	1192	1215	1920																
1100	1292	1315	2040																
1200	1392	1415	2160																
1300	1492	1515	2280																
1400	1592	1615	2400																
1500	1692	1715	2520																
1600	1792	1815										1320	600x	800	120	150	9.00	1.080	
600	792	815	1440																
700	892	915	1560																
800	992	1015	1680																
900	1092	1115	1800																
1000	1192	1215	1920																
1100	1292	1315	2040																
1200	1392	1415	2160																
1300	1492	1515	2280																
1400	1592	1615	2400																
1500	1692	1715	2520																
1600	1792	1815										1320	600x	800	120	150	9.00	1.080	
600	792	815	1440																
700	892	915	1560																
800	992	1015	1680																
900	1092	1115	1800																
1000	1192	1215	1920																
1100	1292	1315	2040																
1200	1392	1415	2160																
1300	1492	1515	2280																
1400	1592	1615	2400																
1500	1692	1715	2520																
1600	1792	1815										1320	600x	800	120	150	9.00	1.080	
600	792	815	1440																

横断用

横断用標準型

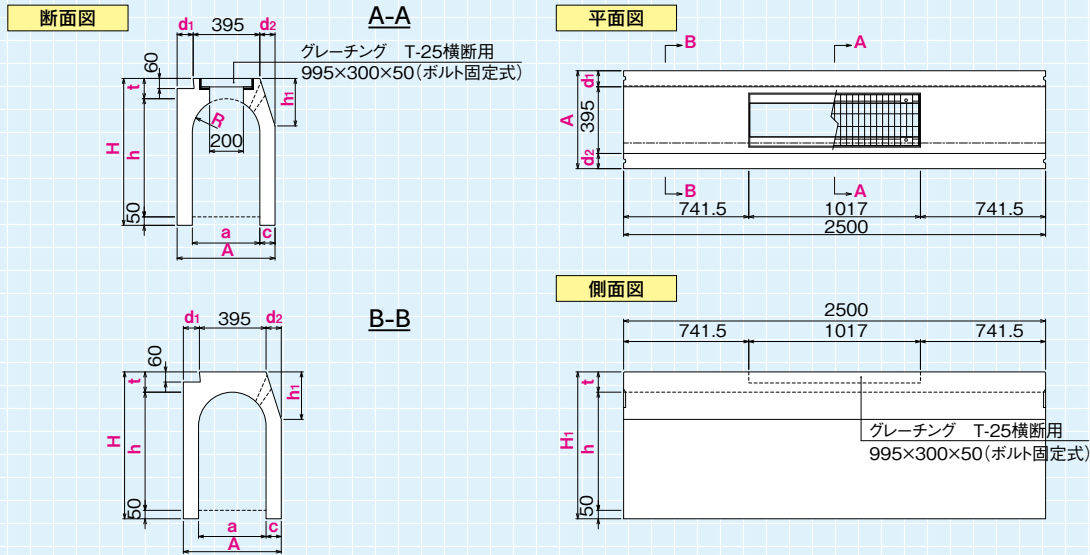

●寸法表

(単位：mm)

呼び名 (a × h)	H	A	t	d ₁	d ₂	c	h ₁	R	参考質量 (kg)
300x	300	455							600
	400	555	470	105	45	30	85	150	710
	500	655							820
	600	755							930
	700	855	470	105	45	30	85	150	1040
	800	955							1150
	900	1055							1260
	1000	1155							1370
	1100	1255	470	105	45	30	85	150	1480
1200	1355							1590	
400x	400	570							810
	500	670	580	120	95	90	90	281	920
	600	770							1030
	700	870							1140
	800	970	580	120	95	90	90	281	1250
	900	1070							1360
	1000	1170							1470
	1100	1270							1580
	1200	1370	580	120	95	90	90	281	1690
1300	1470							1800	
500x	500	700							1240
	600	800	720	150	215	110	110	350	1370
	700	900							1500
	800	1000							1630
	900	1100	720	150	215	110	110	350	1760
	1000	1200							1890
	1100	1300							2020
	1200	1400	720	150	215	110	110	350	2150
	1300	1500							2280
1400	1600							2410	
1500	1700	720	150	215	110	110	350	2540	
600x	600	815							1540
	700	915	830	165	290	145	115	390	1680
	800	1015							1820
	900	1115							1960
	1000	1215	830	165	290	145	115	390	2100
	1100	1315							2240
	1200	1415							2380
	1300	1515	830	165	290	145	115	390	2520
	1400	1615							2660
1500	1715							2800	
1600	1815	830	165	290	145	115	390	2940	

●基礎数量表 (横断用)

(10m 当り)

(1m 当り)

呼び名 (a × h)	A	b ₁	b ₂	基礎材 (m ²)	基礎コンクリート (m ³)	d	主鉄筋	配力筋
300x	300							
	400	470	90	150	5.70	0.513	40	D13 × 4本 D13 × 3本
	500							
	600							
	700	470	90	150	5.70	0.513	40	D13 × 4本 D13 × 3本
	800							
	900							
	1000	470	90	150	5.70	0.513	40	D13 × 4本 D13 × 3本
	1100							
1200								
400x	400							
	500	580	90	150	6.80	0.612	40	D13 × 4本 D13 × 3本
	600							
	700							
	800	580	90	150	6.80	0.612	40	D13 × 4本 D13 × 3本
	900							
	1000							
	1100	580	90	150	6.80	0.612	40	D13 × 4本 D13 × 3本
	1200							
1300								
500x	500							
	600	720	90	150	8.20	0.738	40	D13 × 4本 D13 × 4本
	700							
	800							
	900							
	1000	720	90	150	8.20	0.738	40	D13 × 4本 D13 × 4本
	1100							
	1200							
	1300							
1400	720	90	150	8.20	0.738	40	D13 × 4本 D13 × 4本	
1500								
600x	600							
	700	830	120	150	9.30	1.116	40	D13 × 4本 D13 × 4本
	800							
	900							
	1000							
	1100	830	120	150	9.30	1.116	40	D13 × 4本 D13 × 4本
	1200							
	1300							
	1400	830	120	150	9.30	1.116	40	D13 × 4本 D13 × 4本
1500								
1600								

YCL側溝 可変型(T-25)縦断用・横断用

標準施工図(横断用)

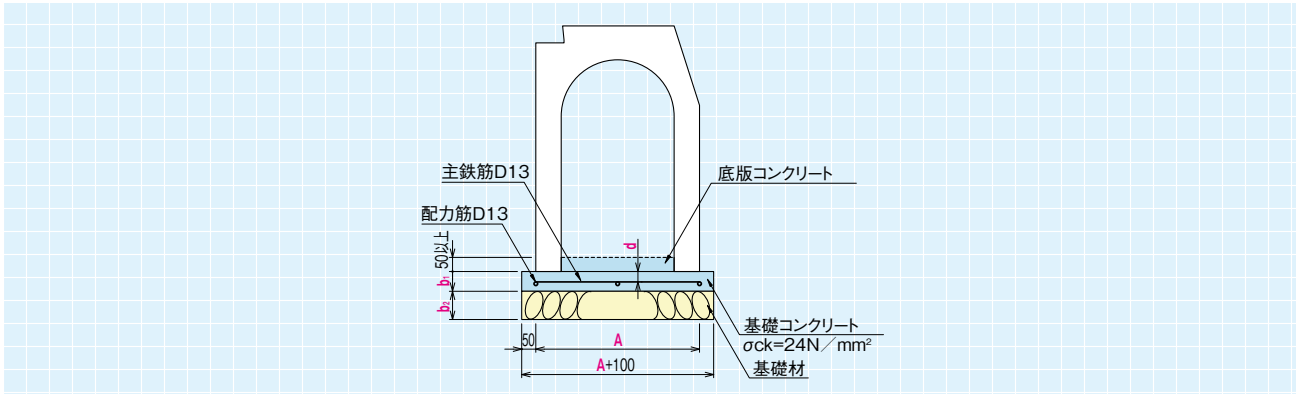

現場打ち柵用蓋構造図

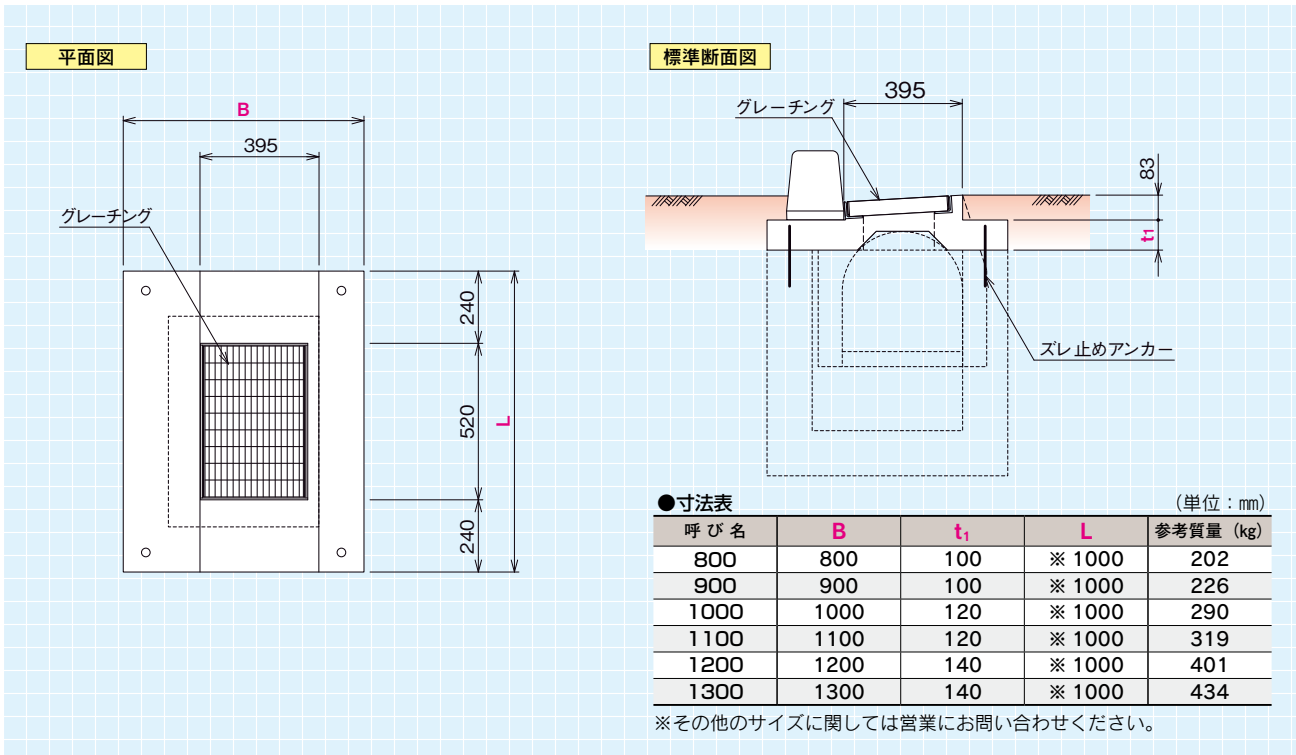

YCL側溝 可変型・管渠型 蓋

